

inspired by technology



→ **pester pharma_filmwrapping**

GLOBAL FLEXIBILITY_We are a dynamic company with a global presence and operate as a network of specialists from various cultures and nations. With this global philosophy we have a unique insight into the latest trends and practices in pharmaceutical packaging. We have learned to think in pharmaceutical dimensions and adapt ourselves to your needs in the diverse world-wide markets. **BRIGHT EYES**_We are characterized by the unique quality of relationships we have with our customers. Be inspired by an open and creative corporate culture. Our highly motivated people make all the difference. **POWERED BY PARTNERSHIP AND NETWORKING**_ The technological perfection of our machines is one thing. We develop long-term partnerships with our customers. This results in turn-key solutions.

pester
pac automation gmbH
Germany
Hauptstraße 50
87787 Wolfertschwenden
Phone +49 (0) 83 34/607-0
Fax +49 (0) 83 34/607-200
info@pester.com
www.pester.com

pester
pac automation
USA
110 Commerce Drive
Allendale, NJ 074 01, USA
Phone +1 (201) 327 7009
Fax +1 (201) 327 7824
pester-usa@pester.com
www.pester.com

pester
pac automation
Benelux
Haringvlietplantsoen 7
NL-2105 ZD Heemstede
Phone +31 (0) 23 547 94 24
Fax +31 (0) 23 547 94 13
pester-benelux@pester.com
www.pester.com

pester
pac automation
France
Boulevard de l'Espérance
Cormelles le Royal
14903 Caen Cedex 09, France
Phone +33 (0) 2 31 83 75 89
Fax +33 (0) 2 31 83 79 02
pester-france@pester.com
www.pester.com

pester
pac automation
Asia
1000/56 PB Tower, 14th Floor,
Wattana, Bangkok, 10110
Phone +66(0)2713 0411
Fax +66(0)2382 2058
bruno-baumann@pester.com
www.pester.com

pester
pac automation
UK
Unit 10 Sunfield Business Park
New Mill Road, Finchampstead
WOKINGHAM, RG40 4QT
United Kingdom
Phone +44 (0) 1189 731 811
Fax +44 (0) 1189 735 085
pester-uk@pester.com
www.pester.com

pester
pac automation
China
Room 507, Jingui Mansion
387, Gu dun Road
310012, Hangzhou, P.R. China
Phone +86 (0) 571 88 85 98 10
Fax +86 (0) 571 88 86 46 55
pester-china@pester.com
www.pester.com

pester pac automation / pharma filmwrapping / 05.2011/e



pester
pac automation

inspired by technology



→ [pester pharma_filmwrapping](#)



INSPIRED BY TECHNOLOGY_ Our strength is innovation. We set trends in pharmaceutical end-of-line packaging. From ampoules or tablets to vials, we package the entire range of products from the pharmaceutical sector. For film and case packaging we invented the balcony construction principle. This provides machinery with intelligent technology, the highest levels of performance and more operating comfort, making the packaging of pharmaceutical products easier and more efficient throughout the world. **PASSION FOR DESIGN AND QUALITY_** Clearly set out, functional and easy to clean – experience modern machine design which satisfies all aspects of your pharmaceutical production. Each Pester machine represents the highest in quality, ranging from the adaptable construction to the hardware and software, up to the simplest operator guidance. Convincing machine technology with top performance and low life-cycle costs. **EASY TO BUY FROM_** We have been active in the world of pharmaceuticals for many years – we understand your requirements and speak your language. Our project managers and a world-wide network of pharmaceutical experts accompany you through the entire process. You benefit from competent advice, short project times and targeted implementation.



PEWO-pack 450

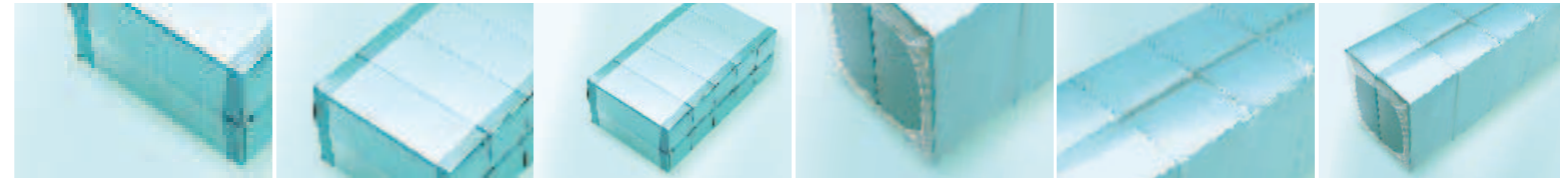

PEWO-pack 250 Compact



► The classic amongst stretchwrapping machines. Packaging technology which has proved itself every day in thousands of pharmaceutical packaging applications. Excellent machine performance, top quality and great value for money.

► TECHNICAL DATA ON PAGE 12

► 1999, the innovation in pharmaceutical design. The world's first stretchwrapping machine in balcony construction according to GMP guidelines. For ampoules, blisters, syringes, tubes and vials – it demonstrates pure pharmaceutical competence. This machine uses the highest level sealing technology which has proved itself in daily pharmaceutical use for decades. Economical, adaptable and ultra-compact.

► TECHNICAL DATA ON PAGE 12



► ACCESSORY

PEWO-collect

When it has to be fast – our collating table for the effective collection and grouping of packages saves time for your operating personnel. A useful addition to all film packaging machines with adjacent manual case packaging.





PEWO-pack 450 Compact cartons



► This modern high performance machine is an outstanding all-rounder for demanding pharmaceutical packaging. It stretch-wraps and shrink-packages all possible variants of folding carton packaging. Whether for ampoules, blisters, syringes, tubes or vials – this is the most versatile and productive stretchwrapping machine ever.

► TECHNICAL DATA ON PAGE 12



PEWO-pack 450 Compact bottles

► Experience ultimate sealing technology at its highest performance. Our new generation high-speed stretchwrapping machine stretch-bands and shrink-packages pharmaceutical bottles with a unique degree of perfection. Using modern servo technology with 'Master-Slave Function' (the speed of the master axis governs all further axes), changeover to new formats is easy, and can be carried out without the use of tools. The transparent shrink tunnel is completely heat-insulated and demonstrates a new dimension of production safety for pharmaceutical products and personnel. Excellent operating comfort, which is a delight to use. ► TECHNICAL DATA ON PAGE 13

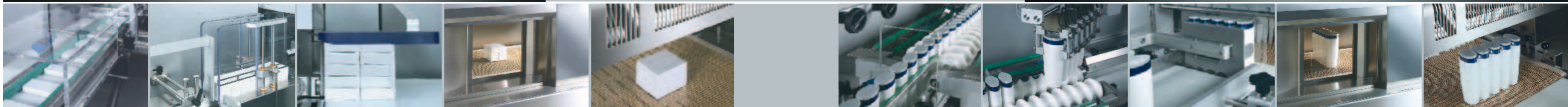
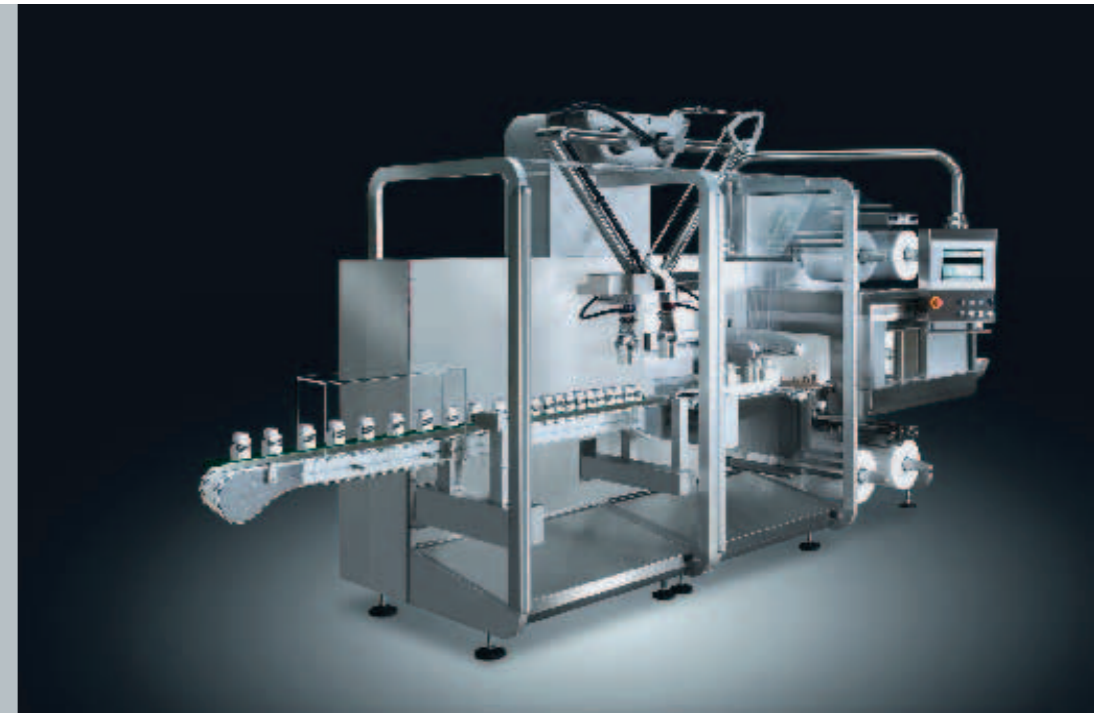



PEWO-fold

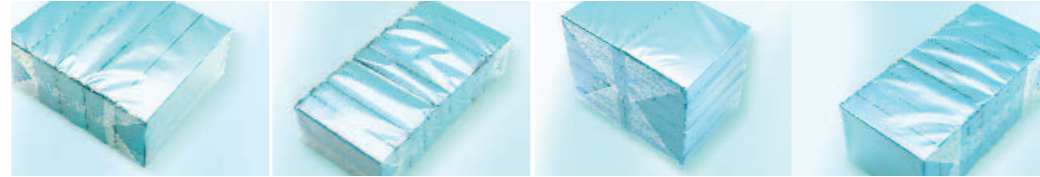

► Full overwrapping technology which concentrates on the essentials. Simple adaptability due to precise parameter settings offers the highest machine efficiency possible. Wear-free sealing technology and maintenance-free machine components achieve unrivaled productivity. Precise film feed using a servo motor, and exact film cutting using a special knife – perfection and safety where it matters.

► TECHNICAL DATA ON PAGE 13

1 MANUAL FILM SPLICER
ADDITIONAL ROLL HOLDER EASES
MANUAL GLUEING OF THE FILM

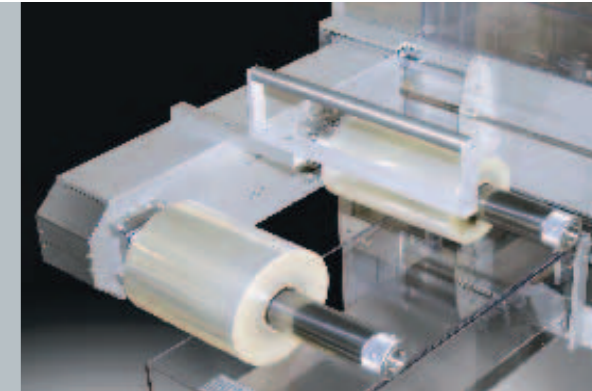

1





PEWO-fold Compact



► Pharmaceutical full overwrapping machine in balcony design according to GMP guidelines. The easiest to adapt to new or different products due to the precise setting of all parameters. Monitored individual transportation into the side-sealing station guarantees perfect packaging, product for product. Film feed, main feed and individual transportation are governed by servo motors. Permanent electronic monitoring ensures temperature-regulated product protection. The wear-free transportation system, which does not require the use of tools, sets standards in productivity.

► TECHNICAL DATA ON PAGE 13

1 FULLY AUTOMATIC FILM SPLICER
AUTOMATIC FILM CHANGE-OVER WHILE THE MACHINE IS RUNNING

2 TEAR-STRIP EQUIPMENT
SIMPLE OPENING OF THE PACKAGING BY FIXING A TEAR-STRIP TO THE FILM

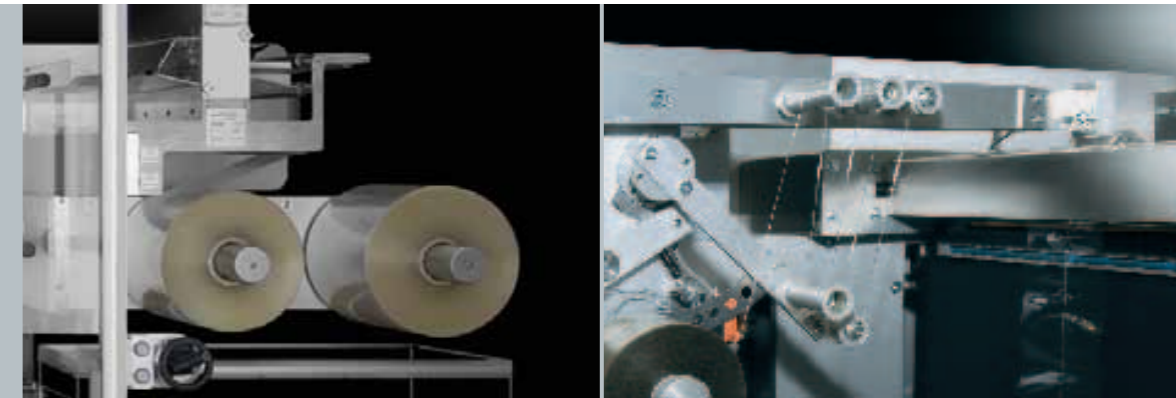

1

2



INDIVIDUAL SERVICE PERFORMANCE

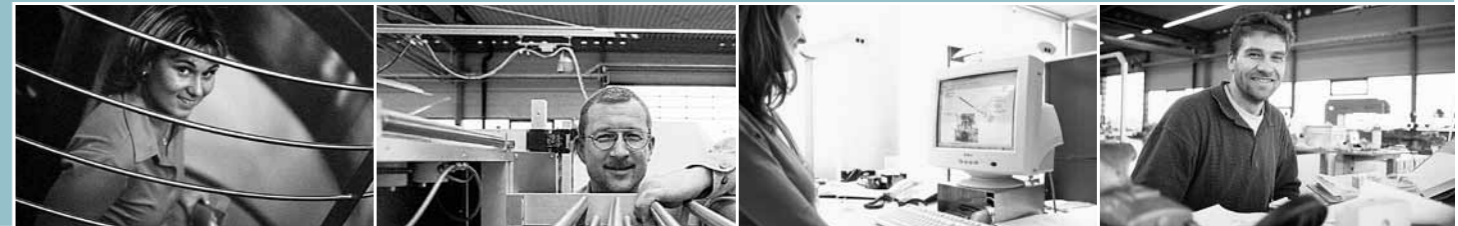

► Experience the benefits of a long-term partnership. We accompany our customers from the initial idea to the fully automated packaging process. Our experts provide the right packaging solution, with complete service, for each phase – all from one source. With individual and personal attention over the whole lifetime of our machines we ensure highest productivity and maximum availability for your Pester machine. Our service network makes the professional know-how of our technical specialists available to you throughout the world. You can decide upon the level of service convenience you require:

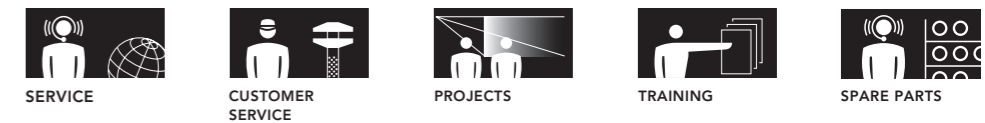

□ 24-HOUR TELEPHONE SERVICE

Whenever you need help quickly, we can be reached through our 24-hour service number, around the clock, seven days a week, even on Sundays and public holidays. Our service specialists are fully prepared and have direct access to your machinery data.

□ ONLINE-SERVICE

With remote diagnostics we ensure that you have short reaction times and optimize your maintenance costs.

□ SPARE PARTS MANAGEMENT

We support your spare parts logistics and ensure the highest efficiency of your machine through the use of original spare parts. Try our preventive spare parts package, or use our Express Service. Spare parts depots throughout the world guarantee highest levels of availability and rapid dispatch.

□ ELECTRONIC SPARE PARTS CATALOGUE

With a single mouse-click you can find the correct spare part and can generate queries or orders from the system. This user-friendly and clear spare parts administration package with 3-D visualization is also available on CD-ROM.

□ FORMAT PARTS BUSINESS

You change your range of products – we deliver the correct format parts for the new requirements. Each tool is unique. Within a very short space of time you receive the format part required, wherever you need it. If you wish, our experts can carry out the installation, start-up on site, and also provide production support.

□ INDIVIDUAL MAINTENANCE PACKAGES

Here, you can decide how much service you need, and choose the right service package, adapted to your production conditions: Service-Basic, Service Plus, or Service-Individual. One thing is certain – your machinery will give reliable production at the highest level, just as on the very first day of installation.

□ ON-SITE SERVICE

Whether in an emergency, just-in-time, or at an agreed date, our service specialists offer you flexible and efficient support. Our world-wide service network of qualified technicians ensures a rapid solution for you.

□ MACHINE UPGRADES

Optimize the efficiency of your lines. With our machine upgrades we bring your Pester machinery up to date with the latest state-of-the-art technology.

□ PROJECT MANAGEMENT

Your requirements in experienced hands. Our project managers, who have a wide range of pharmaceutical experience, accompany you from the coordination and handling of your project through to the delivery, installation and start-up of your machine – right on schedule. You receive all-round service from a single source with a fixed contact partner for the entire period of the project.

□ PHARMACEUTICAL CONSULTING

What will tomorrow's optimum packaging process look like? External project support, line-integration, line functionality, development of specifications and capacity studies – these are only a few of our fields of competence. Our pharmaceutical consulting team is your partner for highly effective production performance.

□ VALIDATION – QUALIFICATION

We show you what we are capable of. Our validation experts provide you with a comprehensive package of services for the qualification of your processes. We provide consistent implementation ranging from risk analysis of DQ, IQ, OQ up to FAT /SAT documents. The knowledge of our staff is always up to date, because we know that every day counts.

□ DOCUMENTATION

We pass our knowledge on to you and speak your language. Whether operating instructions, parts lists or circuit diagrams, our documentation is attractively designed and clear. And should you want more than the standard – we also write special documentation according to your exact requirements.

□ GMP, GAMP, 21 CFR Part 11, PAT...

Always a step ahead in order to stay in the lead. Our experts are constantly at the leading edge and expand their know-how about the latest regulations, requirements and developments in the world of pharmaceuticals on a daily basis. We speak your language and implement your pharmaceutical packaging needs of tomorrow, today.

□ TRAINING

Top machine performance with top personnel. Our training for operators, technicians and specialists provides every-one with exactly what they need. Whether training from our program or individual training, whether in the Pester Training Center or at your site – you benefit from the practical know-how of our experts.

Maintenance

Spare Parts

Telephone Service

Training

**SERVICE
BASIC**

Maintenance

Spare Parts

Telephone Service

Training

SERVICE +

Exclusive Service Hotline

Express Processing for Spare Parts

Guaranteed Reaction Time

Personal Service Manager

THE TECHNICAL OVERVIEW



▶ PAGE 2



PEWO-PACK 450

MACHINE AND PERFORMANCE DATA

Length	1.450 mm
Width	1.000 mm
Height	1.750 mm
Max. film width processed	450 mm
Max. format range	450 x 250 x 250 mm
Performance	45 cycles/min (collations/min)
Material	Polyethylene
Control	Elau, Siemens, Allen Bradley

THE TECHNICAL OVERVIEW

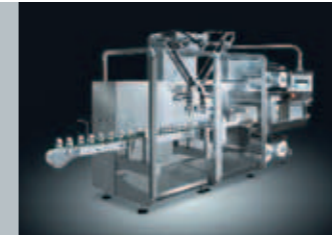

▶ PAGE 5



PEWO-PACK 450 COMPACT BOTTLES

MACHINE AND PERFORMANCE DATA

Length	1.100 – 3.300 mm
Width	1.300 mm
Height	2.000 – 2.600 mm
Max. film width processed	450 mm
Max. format range	300 x 300 x 250 mm
Performance	50 cycles/min (collations/min)
Material	Polyethylene
Control	Elau



▶ PAGE 3



PEWO-PACK 250 COMPACT

MACHINE AND PERFORMANCE DATA

Length	1.100 – 1.900 mm
Width	1.050 mm
Height	1.750 mm
Max. film width processed	250 mm
Max. format range	180 x 400 x 200 mm
Performance	60 cycles/min (collations/min)
Material	Polyethylene
Control	Elau



▶ PAGE 6 | 7



PEWO-FOLD

MACHINE AND PERFORMANCE DATA

Length	1.870 mm
Width	1.000 mm
Height	1.750 mm
Max. film width processed	430 mm
Format range min / max	60 x 60 x 20 mm / 400 x 350 x 140 mm
Performance	60 cycles/min (collations/min)
Material	OPP, PVC, Cellophane, Polyethylene
Control	Elau

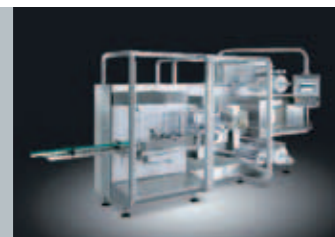

▶ PAGE 4



PEWO-PACK 450 COMPACT CARTONS

MACHINE AND PERFORMANCE DATA

Length	1.100 – 3.300 mm
Width	1.600 mm
Height	2.000 mm
Max. film width processed	450 mm
Max. format range	400 x 400 x 250 mm
Performance	60 cycles/min (collations/min)
Material	Polyethylene
Control	Elau



▶ PAGE 8 | 9



PEWO-FOLD COMPACT

MACHINE AND PERFORMANCE DATA

Length	1.870 – 2.170 mm
Width	1.220 mm
Height	1.750 – 1.850 mm
Max. film width processed	430 mm
Format range min / max	60 x 60 x 20 mm / 250 x 350 x 140 mm
Performance	50 cycles/min (collations/min)
Material	OPP, PVC, Cellophane, Polyethylene
Control	Elau